

INSTALLATION INSTRUCTIONS FOR ASP PHOTOVOLTAIC MODULES

PURPOSE OF THESE INSTRUCTIONS

These instructions contain information regarding the installation and safe handling of photovoltaic modules made by Alpha Solar Planet GmbH.

Alpha Solar Planet GmbH hereafter is referred to as "ASP".

All instructions should be read and understood before installing the modules. The installation of the modules should conform to all the safety precautions in these instructions when installing the modules. The local standards should also be followed in such installations. If there are any questions, please contact our sales department for further assistance.

Before installing a photovoltaic system, the installer should be familiar with the mechanical and electrical requirements for such a system. Keep these instructions in a safe place for future reference (maintenance).

SCOPE

PV modules are ideal for charging storage batteries used to power remote homes, recreational vehicles, boats, telecommunication systems and other electrical applications.

These instructions contain important installation, maintenance and safety information. The word "module" as used in these instructions refers to one or more PV modules.

ASP modules are designed to fulfill the criteria of application class A requirements according to IEC61730 – part 1.

The modules are qualified for application class A: Hazardous voltage (IEC61730: higher than 50 V DC; EN61730: higher than 120 V), hazardous power applications (higher than 240 W) where general contact access is anticipated (Modules fulfilling the safety requirements according to EN IEC 61730-1 and -2 within this application class are considered to meet the requirements for Safety Class II).

DISCLAIMER OF LIABILITY

The installation techniques, handling and use of this product are beyond company control. Therefore, ASP does not assume responsibility for loss, damage or expense resulting from improper installation, handling or misuse.

GENERAL SAFETY INFORMATION

Ensure that the module is used only in applications for which it is suitable (see "Installing Modules"). All work on a PV system (installation, setup, maintenance) must be carried out only by appropriately qualified and authorized engineers.



INSTALLATION INSTRUCTIONS FOR ASP PHOTOVOLTAIC MODULES

The appropriate DIN standards, construction rules and safety instructions must be followed during installation.

WARNING!

PV modules generate electricity as soon as they are exposed to sunlight. One module generates the Safety Extra Low Voltage (SELV) level, but multiple modules connected in series (summing the voltage) or in parallel (summing the current) represent a danger. The following points must be observed when handling the solar modules to avoid the risk of fire, sparking and fatal electric shock.

Do not use mirrors or other magnifiers to artificially concentrate sunlight on the modules!



Do not insert any electrically conducting materials into the plugs or sockets!



Do not fit solar modules and wiring with wet plugs and sockets!



Make sure to use safety equipment (insulated tools, insulated gloves, etc.) when wiring.

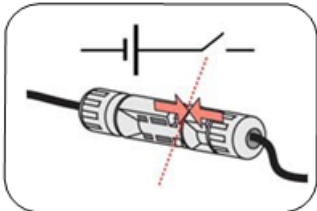

Make sure that you establish a connection only when the circuitry is cut off. Do not disconnect under load.

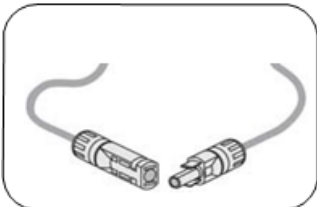

Ensure that the connectors are not polluted and the electrical connection and the mechanical joint is good to avoid the generation of electric arc.



INSTALLATION INSTRUCTIONS FOR ASP PHOTOVOLTAIC MODULES

UNPACKING AND STORING MODULES

Utmost attention is required when handling the modules. Please consider the following cautions when unpacking, transporting and storing the modules:



Do not strike and destroy the modules.

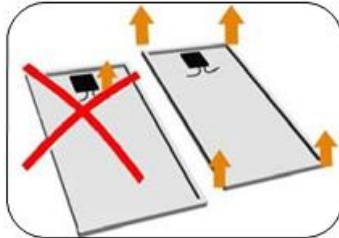

Carry the modules with both hands. Do not use the connection socket as a handle;
Don't lacerate the frame during handling and installing.



Do not stand on the modules.



Do not twist the modules.

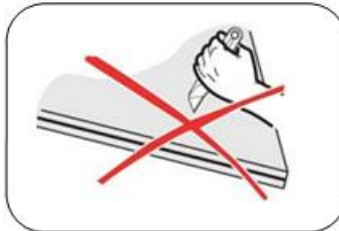

Do not mark the rear of the modules using sharp objects.

INSTALLING MODULES

Before installing your solar system, contact local authorities to determine the necessary permit, installation and inspection requirements which should be followed.



INSTALLATION INSTRUCTIONS FOR ASP PHOTOVOLTAIC MODULES

The system should be installed by qualified personnel only. The system involves electricity, and can be dangerous if the personnel is not familiar with the appropriate safety procedures.

The PV modules should be mounted in a location where they will be receiving maximum sunlight throughout the year. In the Northern Hemisphere, the modules should face south. And in the Southern Hemisphere, the modules should face north.

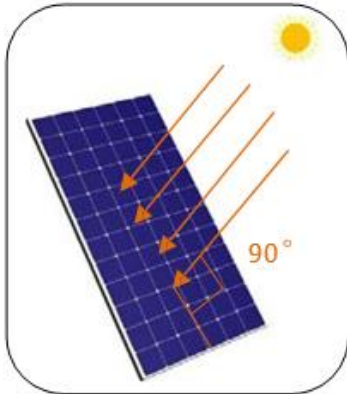

In order to achieve maximum annual yield, optimum orientation and tilt of PV modules is necessary. Sunlight shining vertically onto the PV module is the best condition to generate maximum power. Artificially concentrated sunlight shall not be directed on the module.

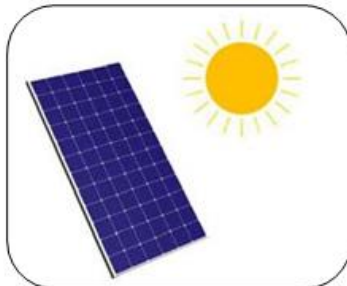

Make sure the modules absorb unobstructed sunlight in order to produce the maximum output.

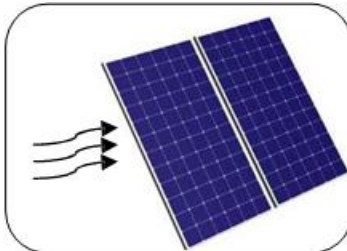

Keeping good ventilation conditions prevents the modules from getting hot, which would reduce the output performance.

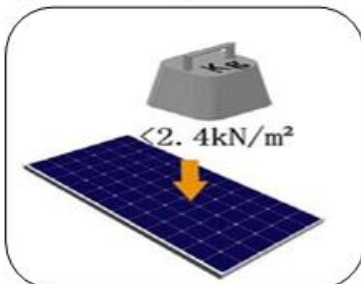

The maximum load on the modules must not exceed 2.4 kN/m^2 . Site-specific environment loads such as wind and snow should be taken into account to avoid exceeding the maximum.



INSTALLATION INSTRUCTIONS FOR ASP PHOTOVOLTAIC MODULES

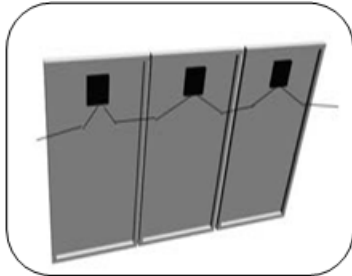

The voltage in series should not exceed the system voltage specified by the manufacturer. When designing a system, for modules connected in parallel it is recommended that a maximum number of four should not be exceeded. For modules connected in series, a maximum number of fifteen should not be exceeded.



The modules must not be installed close to fire or flammable materials.

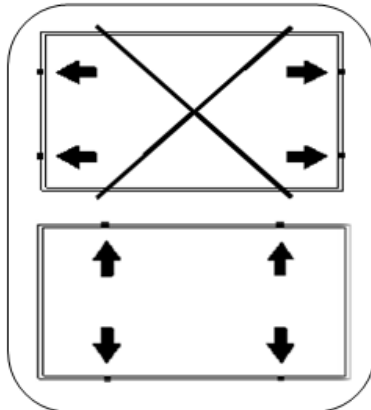

Each module should be fixed at a minimum of 4 points on long frame or short frame and the modules should be supported on the side which is parallel to the surface of the building wall or roof. The assembly must be mounted on a fireproof roof covering which is determined as suitable for the module's application.

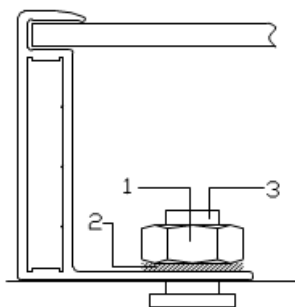

Use the existing installation holes instead of drilling additional holes for installation (drilling holes can compromise the reliability and warranty of the modules). The installation and attachment materials (nuts, bolts, etc.) must be corrosion-resistant. The moment of force is 5 N·m for module mounting.

- 1 Stainless steel M8 nut
- 2 Stainless steel spring washer
- 3 Stainless steel M8 t-head bolt

Grounding

Despite the fact that the modules meet the safety qualification requirements, grounding must be used. The grounded connection must be made by a qualified electrician.



INSTALLATION INSTRUCTIONS FOR ASP PHOTOVOLTAIC MODULES

Connect module frames to each other using cables with cable lugs.

All the junctions on the conductive connection must be fixed. Soldering is not required.

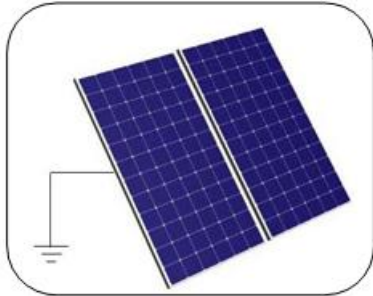

- The metallic frames must be grounded according to Article 250 of the U.S. NEC. and should provide appropriate engagement through the anodized layer.
- The PV system should be operated with a reliable lightning protection system.

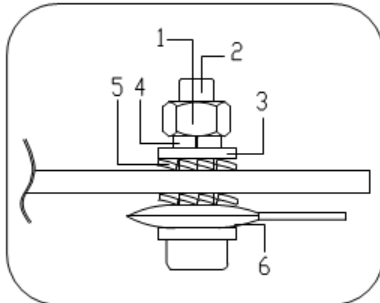

- 1 stainless steel nut M4
- 2 stainless steel bolt M4x30
- 3 stainless steel flat washer M4
- 4 stainless steel spring washer M4
- 5 stainless steel serrated washer M4
- 6 stainless steel slotted washer M4

All ferrous metal in the conductive connection should be specially treated, e.g. by anodization, spray-painting, galvanization. Stainless steel does not need to be treated.

WIRING

To ensure proper wiring, pay close attention to:

- CORRECT WIRING SCHEME

When designing the system, avoid forming a closed loop. Check that the wiring is correct before starting the generator. If the measured open circuit voltage (Voc) and short-circuit current (Isc) differ from the specifications, then there may be a wiring fault.

- CORRECT CONNECTION

The cross sectional area of wire and the capacity of connector must be selected to suit the maximum system short circuit current (the area of the cable mated with the connector is recommended to be 4–6 mm²), otherwise the cable and connector will be overheated under high current. The upper temperature limit of the cable is 1,200 °C and of the connector 1,000 °C. The ambient temperature range of cable and connector is -40 °C to 90 °C. The plug connector has its own polarity. Make sure that the connection is safe and tight. The plug connector should not be exposed to external stress. Connectors should only be used to connect the circuit, but never to turn the circuit on or off.

- USE OF SUITABLE MATERIALS



INSTALLATION INSTRUCTIONS FOR ASP PHOTOVOLTAIC MODULES

Use cable extensions and plugs that are designed for outdoor applications. Ensure that they are in perfect electrical and mechanical condition. Only cables with one conductor are used.

Ensure that all materials meet the requirements of the system maximum voltage, current, moisture, and temperature when they are exposed to sunlight. Under normal conditions, a photovoltaic module is likely to produce more current and/or voltage than that reported under standard test conditions. Accordingly, the values of I_{sc} and V_{oc} marked on this module should be multiplied by a factor of 1.25 when selecting electricity components voltage ratings, conductor capacities, fuse type, and type of control components connected to the PV output.

The maximum series fuse rating is 10 A (module with 5' cells) or 15 A (module with 6' cells). The maximum reverse current is calculated by multiplying the series fuse rating by a factor of 1.35.

- **BYPASS DIODES**

When modules in series are shaded partially, this may result in reverse voltage across cells or modules, which may cause undesirable heating to occur. The use of a diode to bypass the shaded area can minimize both heating and array current reduction.

All ASP modules are equipped with factory installed bypass diodes. The factory installed diodes provide proper circuit protection for the system. Rating of bypass diodes: current 10 A; voltage 50 V.

- **OTHER**

During installation, be sure to tie the cable from the junction box to the mounting substructure with nylon line, etc. to avoid direct contact of the cable with the back surface of the module.

MODULE MOUNTING

ASP's Limited Warranty for modules is based upon modules being mounted in accordance with the conditions below.

OPERATING CONDITIONS

ASP modules should be used under the following operating conditions:

- The operating temperature of ASP modules should be between -40 °C (-40 °F) and 85 °C (185 °F).
- Ensure adequate ventilation behind the modules in hot environments.
- The modules are capable to bear heavy snow loads up to 5,400 Pa and wind loads up to 2,400 Pa
- The installation site should be less than 1,000 m (3,280 ft) above sea level. Installation above 1,000 m (3,280 ft) is allowed only if the wind pressure load for a module is less than 2,170 N/m² (45 psf).



INSTALLATION INSTRUCTIONS FOR ASP PHOTOVOLTAIC MODULES

LIMITED CONDITIONS

Installation environments with the following conditions should be avoided:

- Installation sites exposed to extreme sand and dust damage.
- Installation sites exposed to extreme air pollution, chemical vapors, acid rain, and/or soot, etc.
- Installation sites exposed to frequent hail and snow.
- Installation sites exposed to extreme salt damage.

CHECKLISTS

- All fastenings are tight, secure and free of corrosion.
- All cable connections are secure, tight, clean and free of corrosion.
- Cables are not damaged in any way.
- Verification of the grounding resistivity of metals.

MAINTENANCE AND CLEANING

Do not exchange PV components (diode, junction box, plug connectors) that can be serviced by ASP-authorized distributors or dealers without voiding the warranty.

Install the module with sufficient tilt (at least 15°) to benefit from a self-cleaning effect under normal conditions (rainfall will have a self-cleaning effect). In case of heavy soiling of the module (which will result in output reductions), use a gentle cleaning tool (such as a sponge) and water (from a hose) without cleaning agents to rinse the modules. Dried dirt must never be scraped or rubbed as scraping and rubbing the module surface will cause micro-scratching. Periodic inspection must be done for the system.

